



# Christmas Memories

A NeedleKnowledge® Quilt Pattern

## Before Beginning...

- ◆ Carefully read the instructions before starting the project
- ◆ Pre-wash and press all fabrics before cutting. Replace any fabrics that continue to bleed after washing
- ◆ All seam allowances are 1/4 inch and are included in the given measurements
- ◆ Press seams as you work, and always press towards the darker fabrics whenever possible. Small pieces can be finger-pressed to save trips to the ironing board
- ◆ Be sure to follow the printing instructions on the last page

Every effort has been made to ensure the accuracy of this pattern. We cannot, however, be responsible for human error, typographical mistakes, improper printer settings and variations, or variations in an individual's work.

## Cut the Santa Block Pieces:

From the red fabric cut one (1) R piece and one (1) reversed (r) R piece. Cut two (2) O pieces, one (1) G piece, one (1) D piece, two (2) B pieces, two (2) P pieces and two (2) K pieces.

From the white fabric cut one (1) D strip, one (1) M strip, one (1) N strip and two (2) P strips.

From the off-white fabric cut one (1) F piece. Transfer markings to the piece.

From the deep green fabric cut two (2) P pieces.

From the black fabric cut two (2) J pieces.

From the pale pink fabric cut one (1) A piece.

From the pale peach fabric cut three (3) C pieces and two (2) E pieces.

From the deep blue fabric cut two (2) A pieces.

From the light blue print cut two (2) A pieces, two (2) L pieces, one (1) D piece, one (1) I piece and one (1) reversed(r) I piece, one (1) H piece and one (1) reversed (r) H piece and one (1)S piece.



Sadly, this information must be placed here...

Copyright ©NeedleKnowledge and Cheryl Fall.

All Rights Reserved through the US Copyright Office and the World Intellectual Property Organization Copyright Treaty (adopted in Geneva on December 20, 1996) and subsequently accepted/adopted/ratified by the bulk of the nations in which servers and service providers reside.

Please respect CopyRight Law. This material may not be copied or redistributed in any format, including printed and/or electronic formats, without the written consent of NeedleKnowledge® or Cheryl Fall. NeedleKnowledge® is a registered trademark.

# Assemble the Santa Block:

To make Santa's hat section, stitch one blue H and one reversed H to the red G triangle (Fig. 12). Stitch one blue L to one red R, white P, Green Q, and one red P piece to make Santa's left arm (Fig. 13).



Fig.12

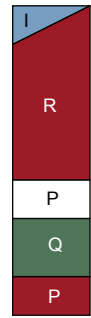

Fig.13

Stitch the hat section above the arm unit to make a strip. This is the left-hand side of the Santa block (Fig. 14). Assemble Santa's right-hand side by making a mirror image of Santa's left arm (using the reversed I and R pieces) and topping off with a blue S piece (Fig. 15)



Fig.14  
left side

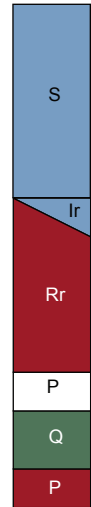

Fig.15  
right side

Stitch one red and one white D strip together. Alternate two deep blue A pieces with 3 pale peach C pieces. Stitch one pale peach E piece to each side of one red A piece. Stitch these three units together to form Santa's head (Fig. 16)

Stitch one red B triangle to each lower corner of the white F piece. transfer markings to F piece (Fig. 17) to make the beard section. Stitch one red O piece to each side of the white N piece to make the belly section (Fig. 18).

Stitch the head section, beard section and belly section together to form Santa's body. Stitch the left and right arm section to Santa's body.

To make the leg sections, stitch the L, K, A and J units together - one facing left and one facing right (Fig. 19).

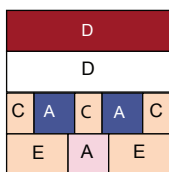

Fig.16

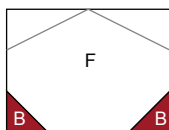

Fig.17

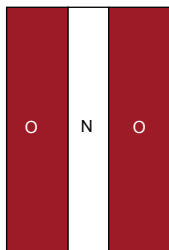

Fig.18

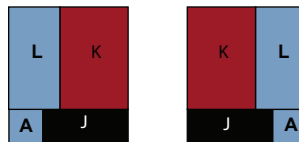

Fig.19

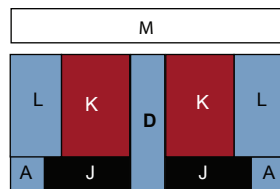

Fig.20

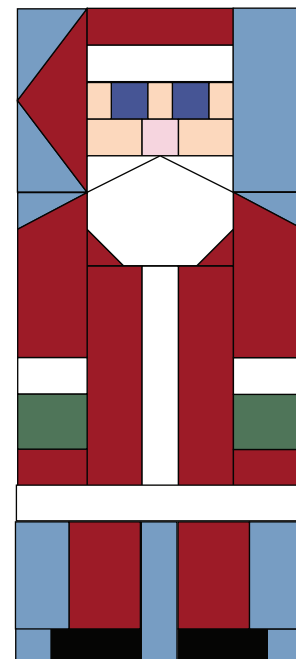
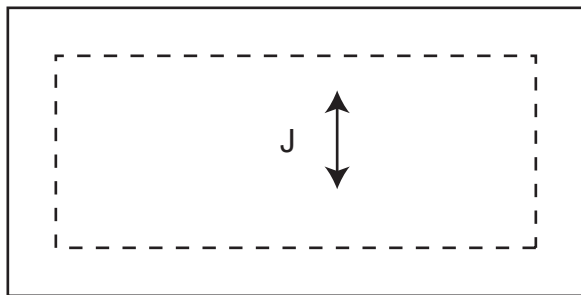
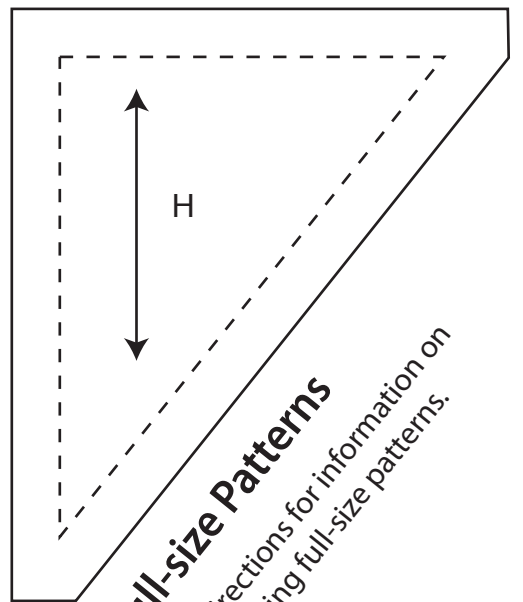
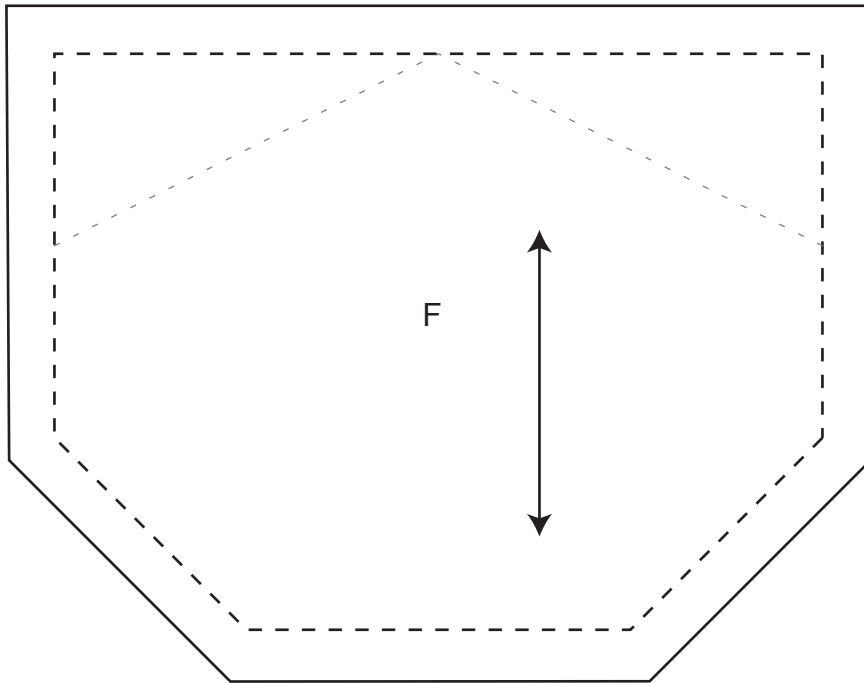
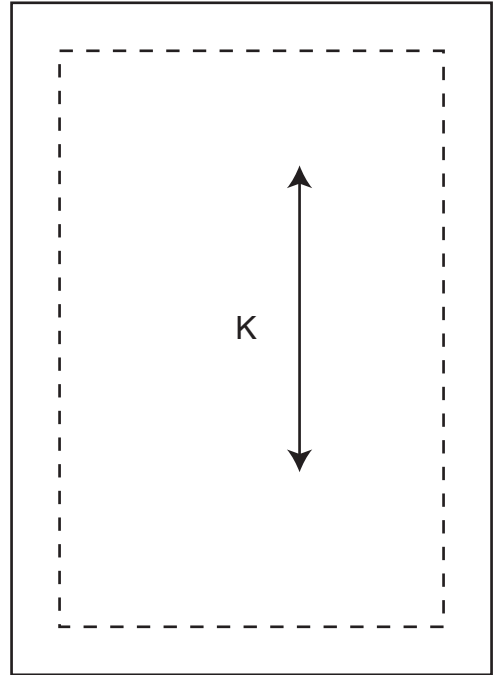
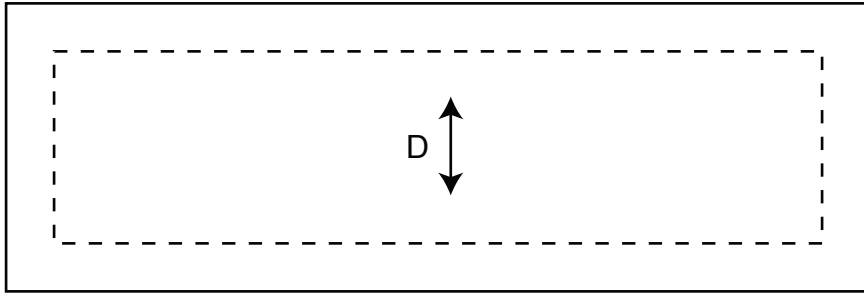
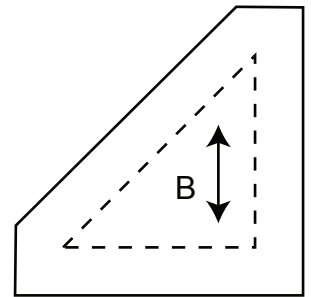
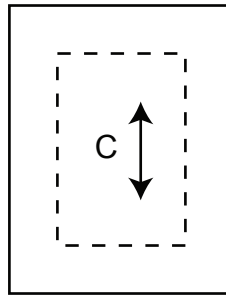
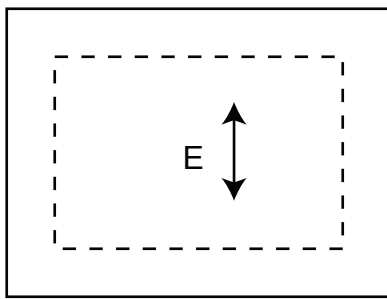
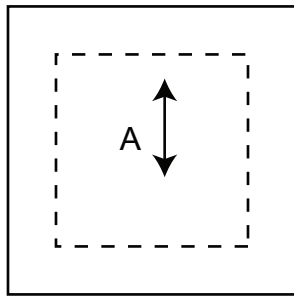

Fig.21



**Full-size Patterns**  
See main directions for information on properly printing full-size patterns.

## Full-size Patterns

See main directions for information on properly printing full-size patterns.

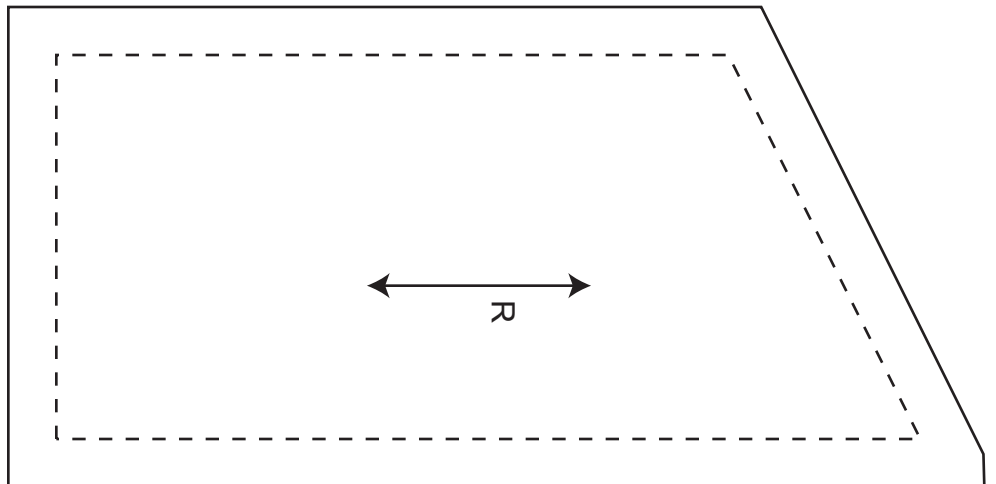
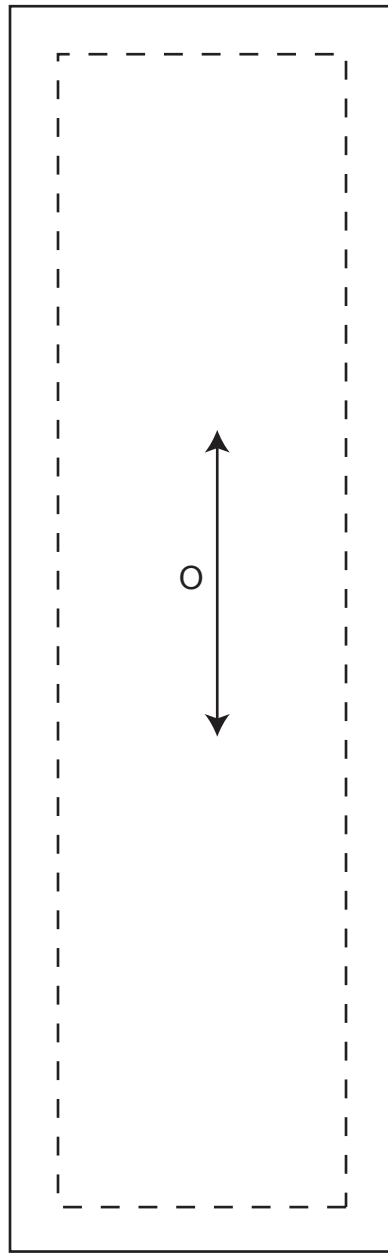
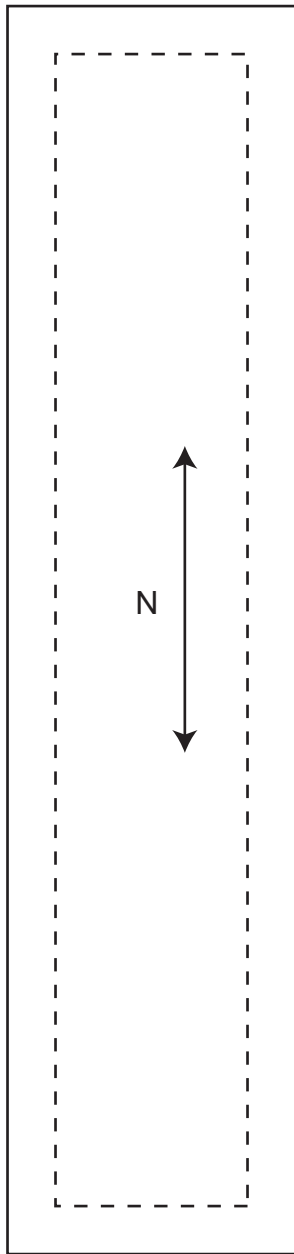
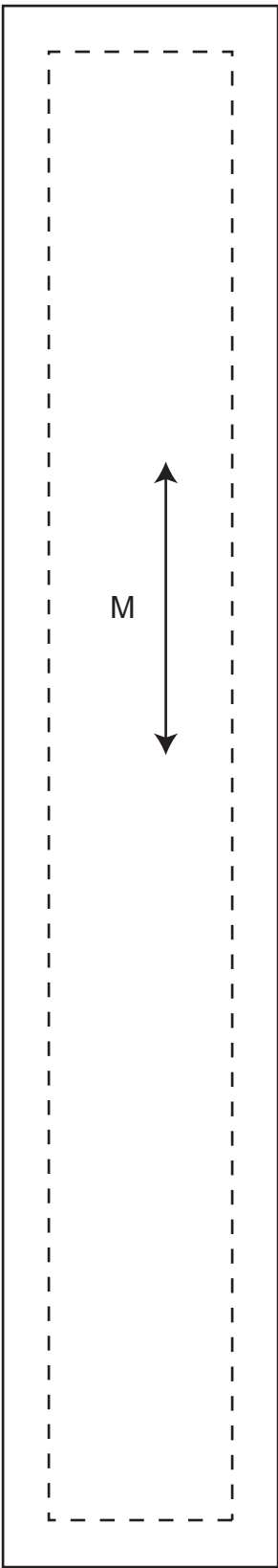

## Full-size Patterns

See main directions for information on properly printing full-size patterns.

